

ELLIS

DESIGNED BY HERVÉ LANGLAIS

Empiètement des années 30 revisité pour ce lampadaire à l'allure classique, mais aux détails résolument contemporains. Les embouts polis, qui viennent finir la ligne en bout de tube, sont personnalisables à la demande.











A step back in time for this remake of a classical 1930's floor lamp, redesigned with contemporary details. The polished tips at the end of each brass tubes are customizable on request.



Ellis SB/PB

**Finitions
Finishes** ①+②*Détails page 222*

 Laiton satiné SB Satin brass	 Graphite satiné SG Satin graphite	 Nickel satiné SN Satin nickel	 Cuivre satiné SC Satin copper
 Laiton poli PB Polished brass	 Graphite poli PG Polished graphite	 Nickel poli PN Polished nickel	 Cuivre poli PC Polished copper



**Abat-jour
Lampshade**

 Drop Paper® 100	 Drop Paper® 101	 Drop Paper® 103
---	---	---

**Matériaux
Material**

Laiton massif Solid Brass	Abat-jour Drop Paper® M1 Lampshade Drop Paper® M1	Câble textile noir (longueur ≈ 2 m) Black textile cable (length ≈ 79")
------------------------------	--	---

**Source
Lamping**

Lampadaire – Floor lamp 1 x E27 205 W max. Ampoule non fournie 1 x E27 205 W max. Bulb not included	Variateur à pied Foot operated dimmer	Variation* Dimming*
1 x E26 type A 150 W. Bulb not included	Foot operated switch	
Lampe de table – Table lamp 1 x E27 105 W max. Ampoule non fournie 1 x E27 105 W max. Bulb not included	Interrupteur sur câble Cable switch	
1 x E26 type A 100 W. Bulb not included	Cable switch	

Designer

Hervé Langlais

* Les luminaires variables nécessitent l'utilisation d'ampoules compatibles avec la variation
All dimmable light fixtures require the use of compatible bulbs



Ellis SB/PB

Lampadaire – Floor lamp

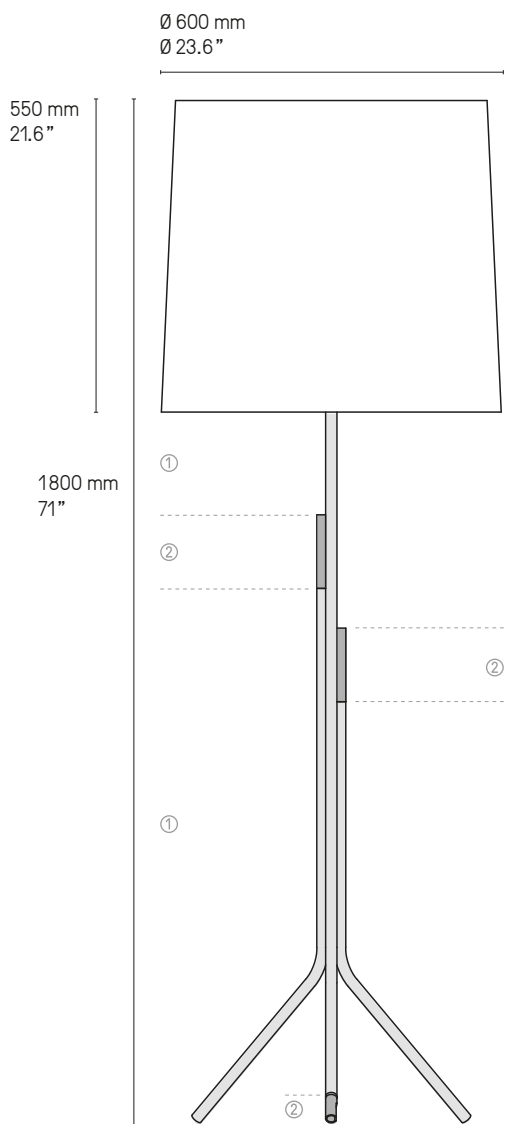

Lampe de table – Table lamp

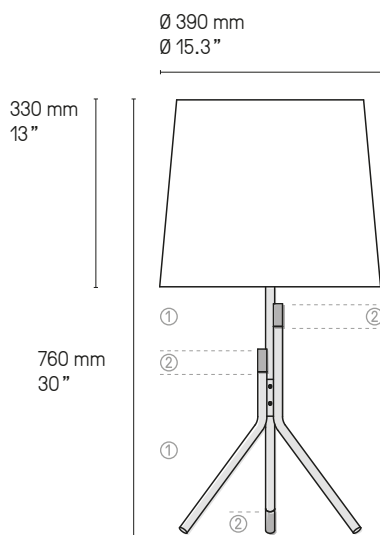

Version LED et DALI sur demande.
LED and DALI version upon request.



© Yannick Labrousse

CVL LUMINAIRES

79 ROUTE DE LA CHEVALLERIE – 49770 LONGUENÉE-EN-ANJOU – FRANCE

TEL. +33 (0) 2 41 32 67 54

EMAIL : CONTACT@CVL-LUMINAIRES.FR

WWW.CVL-LUMINAIRES.FR

Brand identity & art direction: [POOL](#) Layout & production supervision: [deuxpointdeux](#)
Texts & translation: [CVL](#) Photos: [Garnier Studios](#) except when mentionned otherwise 3D: [CVL](#) except when mentionned otherwise

Make sure to download our latest catalogue [here](#)