

design — Mauro Lipparini



Katana, 026/TC3
tavolo \ table

A decretare l'unicità del tavolo Katana è il peculiare disegno delle gambe in metallo, che richiama le antiche spade giapponesi a lama curva dalle quali il prodotto prende il nome. Proposta versatile, Katana è un tavolo pensato per adattarsi ai contesti all'aria aperta, proposto sia in una versione a tre gambe con piano tondo Ø120 e Ø130 cm, sia in una rettangolare a quattro gambe, entrambe con piano in grès porcellanato o HPL.

The uniqueness of the Katana table is underlined by the peculiar design of the metal legs that recalls the ancient curved blades of Japanese swords, from which the product gets its name. Katana is a versatile proposal, adaptable to open air contexts, available with round top Ø120 e Ø130 cm - with or without Lazy Susan - or rectangular top with four legs, in laminated porcelain or HPL.

Informazioni tecniche \ *Technical information*

Descrizione tecnica \ *Technical description*

Tavolo tondo con tre gambe in metallo verniciato.
Piano in HPL o grès porcellanato.
Finiture di collezione.

*Round table with three legs in painted metal.
Top in HPL or laminated porcelain.
Materials as per collection.*

Dimensioni \ *Dimensions*

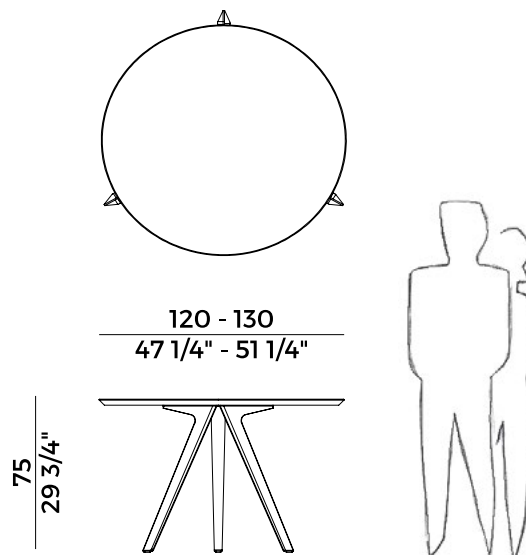

Ø120

laminated porcelain - 1 crt = m³ 1.80

HPL - 3 crt = m³ 0.28

gross weight laminated porcelain - Kg 113

gross weight HPL - Kg 61



Ø130

laminated porcelain - 1 crt = m³ 2.00

HPL - 3 crt = m³ 0.30

gross weight laminated porcelain - Kg 120

gross weight HPL - Kg 66

Finiture \ *Finishes*

Finiture base \

Base finishes

Metallo \ *Metal*

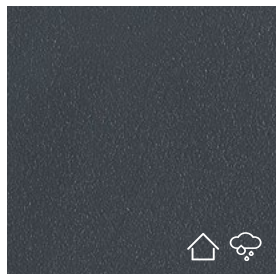

Verniciato Antracite Goffrato \
Anthracite Embossed Lacquered

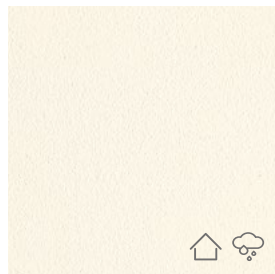

Verniciato Bianco Goffrato \
White Embossed Lacquered

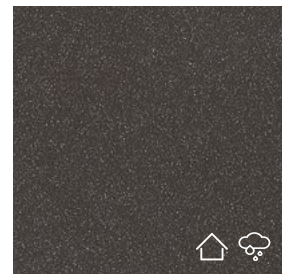

Verniciato Aval Goffrato \
Aval Embossed Lacquered

Finiture piano \

Top finishes

Grès Porcellanato \ *Grès Porcellanato*

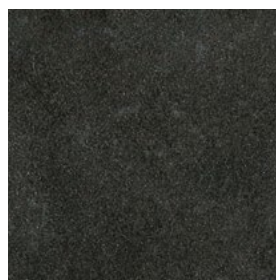

Ossido Nero \
Black Ossido

HPL \ *HPL*

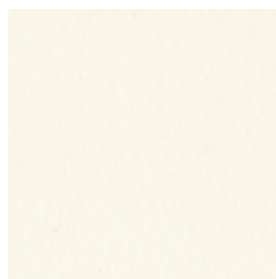

Bianco \
White

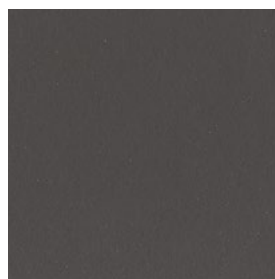

Antracite \
Anthracite



Orchidea \
Orchid

**Collezione Katana **
Katana collection

Famiglia di tavoli con gambe in metallo verniciato.
Tavolo tondo con tre gambe.
Tavolo rettangolare con quattro gambe.
Piano in HPL o grès porcellanato.
Finiture di collezione.

*Family of tables with legs in painted metal.
Round table with three legs.
Rectangular table with four legs.
Top in HPL or laminated porcelain.
Materials as per collection.*

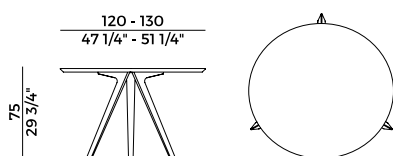

026/TC3

tavolo \ table

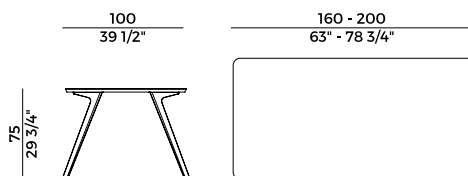

026/TR4

tavolo \ table