

EARTH

DESIGNED BY ÉMILIE CATHELINÉAU

Un cœur lumineux, serti d'un métal ajouré de manière extrêmement fine ou d'un disque plein, confère à cette collection une touche Art déco. Du clair-obscur au moucharabieh, les idées de composition sont variées.



This wall light, with an illuminated center, assembled with an extremely fine openwork or a fully covered piece of metal gives this collection an Art déco style. From semi-darkness to a patterned light source, arrangements can vary.



Finitions
Finishes ①+②

● Laiton satiné
SB Satin brass

● Graphite satiné
SG Satin graphite

● Nickel satiné
SN Satin nickel

● Cuivre satiné
SC Satin copper

Matériaux
Material

Laiton massif
Solid brass

Diffuseur en polycarbonate
Polycarbonate diffuser

Source
Lamping

LED intégrée 1080 lm 2700°K
Integrated LED 1080 lm 2700°K

Alim. électronique 24 V intégrée
Integrated 24 V power supply

Variation. Veuillez nous contacter
Dimming. Please, contact us



Designer

Émilie Cathelineau

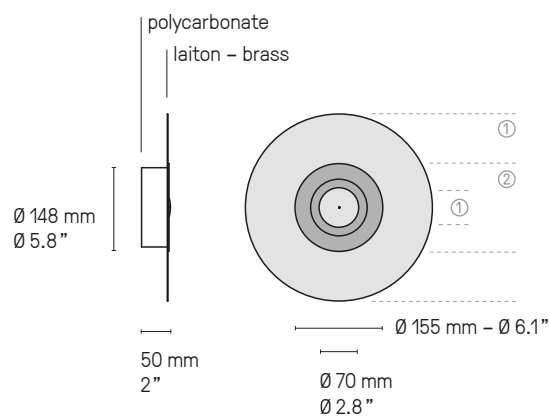

Partie centrale identique pour tous les modèles, quels que soient la taille et le motif.
Identical central part for all *Earth* fixtures for any size and design.



Earth Radian SB/SG

Earth Sober

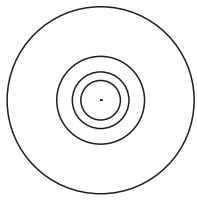

Ø 330 mm
Ø 13"

Disponible en Ø 250 mm
Available in Ø 9.8"



Earth Sober 330 SN/SG

Earth Radian

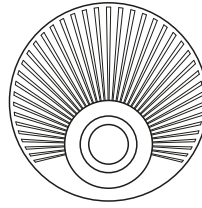

Ø 350 mm
Ø 13.8"



Earth Radian 350 SB/SG

Earth Mandala

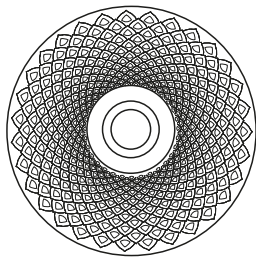

Ø 440 mm
Ø 17.3"

Disponible en Ø 330 mm
Available in Ø 13"



Earth Mandala 440 SB/SG

Earth Palm

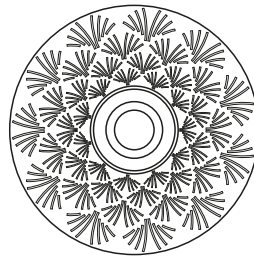

Ø 440 mm
Ø 17.3"

Disponible en Ø 330 mm
Available in Ø 13"



Earth Palm 330 SB/SG

Earth Sun

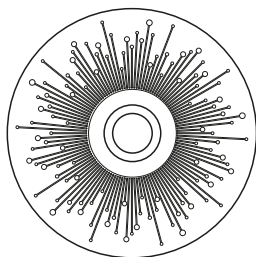

Ø 440 mm
Ø 17.3"

Disponible en Ø 330 mm
Available in Ø 13"



Earth Sun 440 SB/SG

Earth Turtle

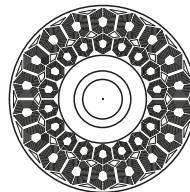

Ø 330 mm
Ø 13"

Disponible en Ø 440 mm
Available in Ø 17.3"



Earth Turtle 330 SG/SB



Earth Sun 330 SC/S6



Earth Radian 350 SB/SG

© Guillaume Grasset for Laurent Maugoust

NUANCIER - FINISH OPTIONS



LAITON - BRASS

- | | |
|-------------------------------------|---|
| ① Laiton satiné
SB Satin brass | ② Graphite satiné
SG Satin graphite |
| ③ Nickel satiné
SN Satin nickel | ④ Cuivre satiné
SC Satin copper |
| ⑤ Laiton poli
PB Polished brass | ⑥ Graphite poli
PG Polished graphite |
| ⑦ Nickel poli
PN Polished nickel | ⑧ Cuivre poli
PC Polished copper |

ABAT-JOURS - LAMPSHADES

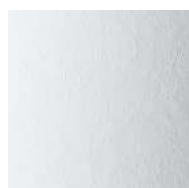

Drop Paper® 100



Drop Paper® 101



Drop Paper® 103



Chinette blanche
White chinette

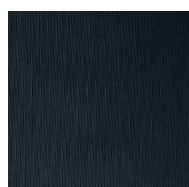

Chinette noire
Black chinette

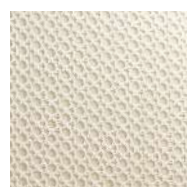

Duke
Duke

CÂBLES - CABLES

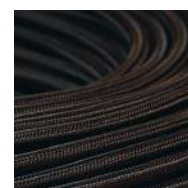

Tissu noir
Black textile



Tissu or
Gold textile

VERRERIE - GLASS



Opale
Opal



Opale et écaille
Opal and patterned



Claire et écaille
Clear and patterned



© Yannick Labrousse

CVL LUMINAIRES

79 ROUTE DE LA CHEVALLERIE – 49770 LONGUENÉE-EN-ANJOU – FRANCE

TEL. +33 (0) 2 41 32 67 54

EMAIL : CONTACT@CVL-LUMINAIRES.FR

WWW.CVL-LUMINAIRES.FR

Brand identity & art direction: [POOL](#) Layout & production supervision: [deuxpointdeux](#)
Texts: [Valérie Marion](#) Translation: [CVL](#) Photos: [Garnier Studios](#) except when mentioned otherwise 3D: [CVL](#) except when mentioned otherwise

Make sure to download our latest catalogue [here](#)